

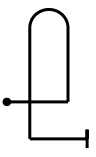

	Form A
Pilot ID	AAC Sportsman Known
Flight #	

No	Symbol	Cat. No.	K	Total K	Grade	Pos	Remarks	Item	K	Grade
1		8.4.1.1	13	13	.			Pos.	15	
2		8.5.6.1 9.1.4.2	10 4	14	.			Fig K	113	Total K 128
3		7.4.1.1	10	10	.			Penalties		
4		5.2.1.1	17	17	.			Too Low		
5		1.1.2.1	7	7	.			Too High		
6		1.1.6.3 9.11.1.6	10 3	13	.			Interruptions		
7		7.3.2.1 9.1.2.2	14 6	20	.			Insertions		
8		2.1.1.1	3	3	.			Trg Violation		
9		2.3.1.1	5	5	.			Wing Rocks		
10		1.1.1.1 9.2.3.4	2 9	11	.			Disqual Fig		
								Other(note...)		
								Final Freestyle		
								Duration	Min	Sec
								Judges Details		
								Signature		
								Name		
								Number		

Pilot
A/C

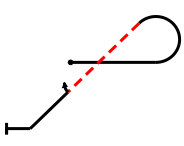
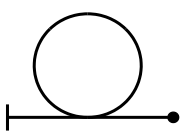
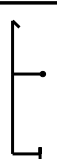
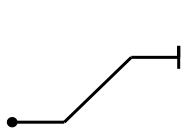

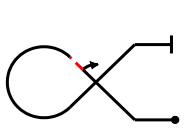
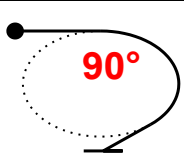
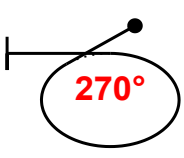
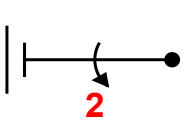
		Form B
Pilot ID	AAC Sportsman Known	Flight #

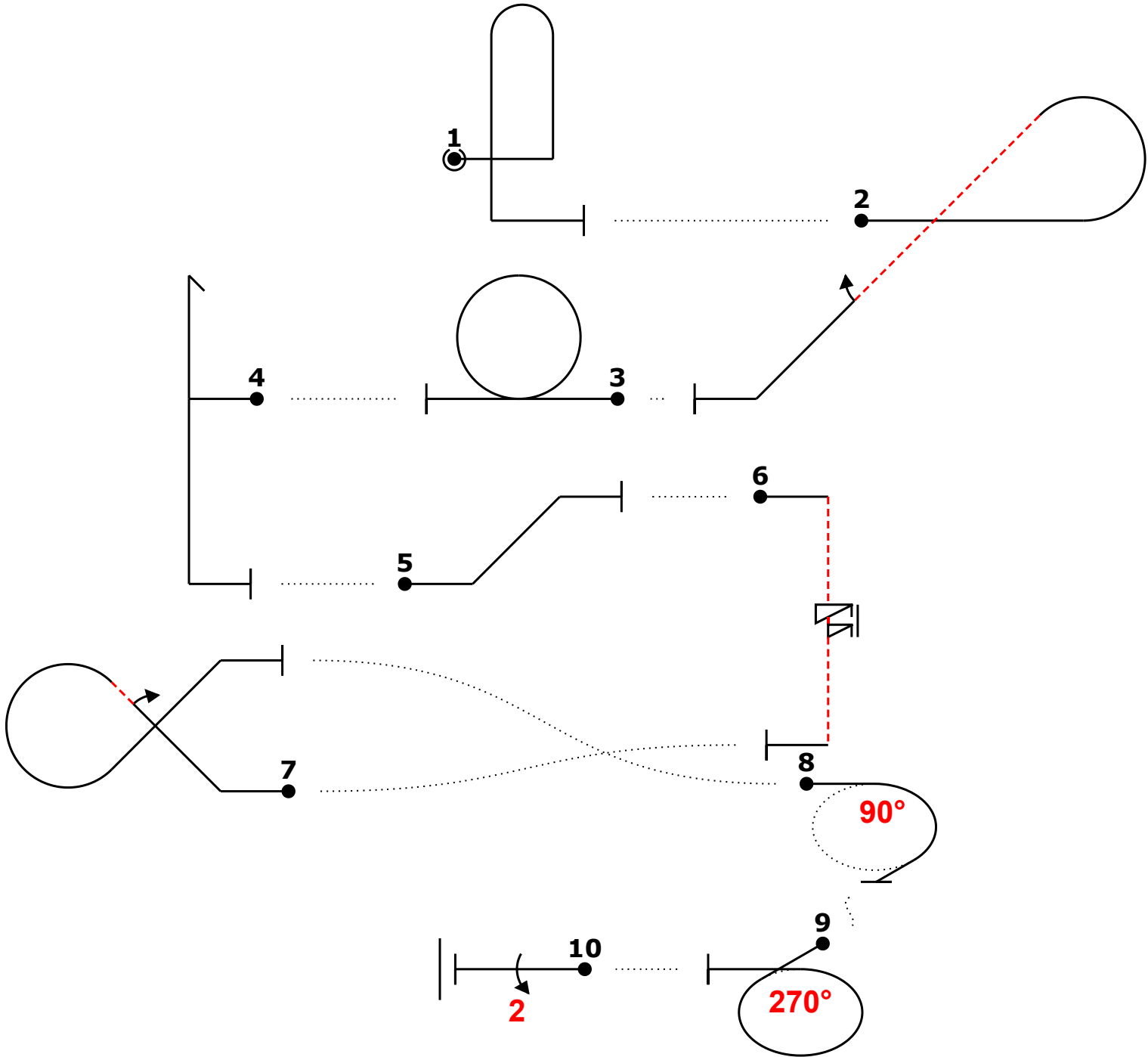
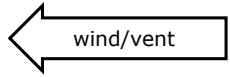

Pilot
.....
A/C

		Form C
Pilot ID	AAC Sportsman Known	
		Flight #

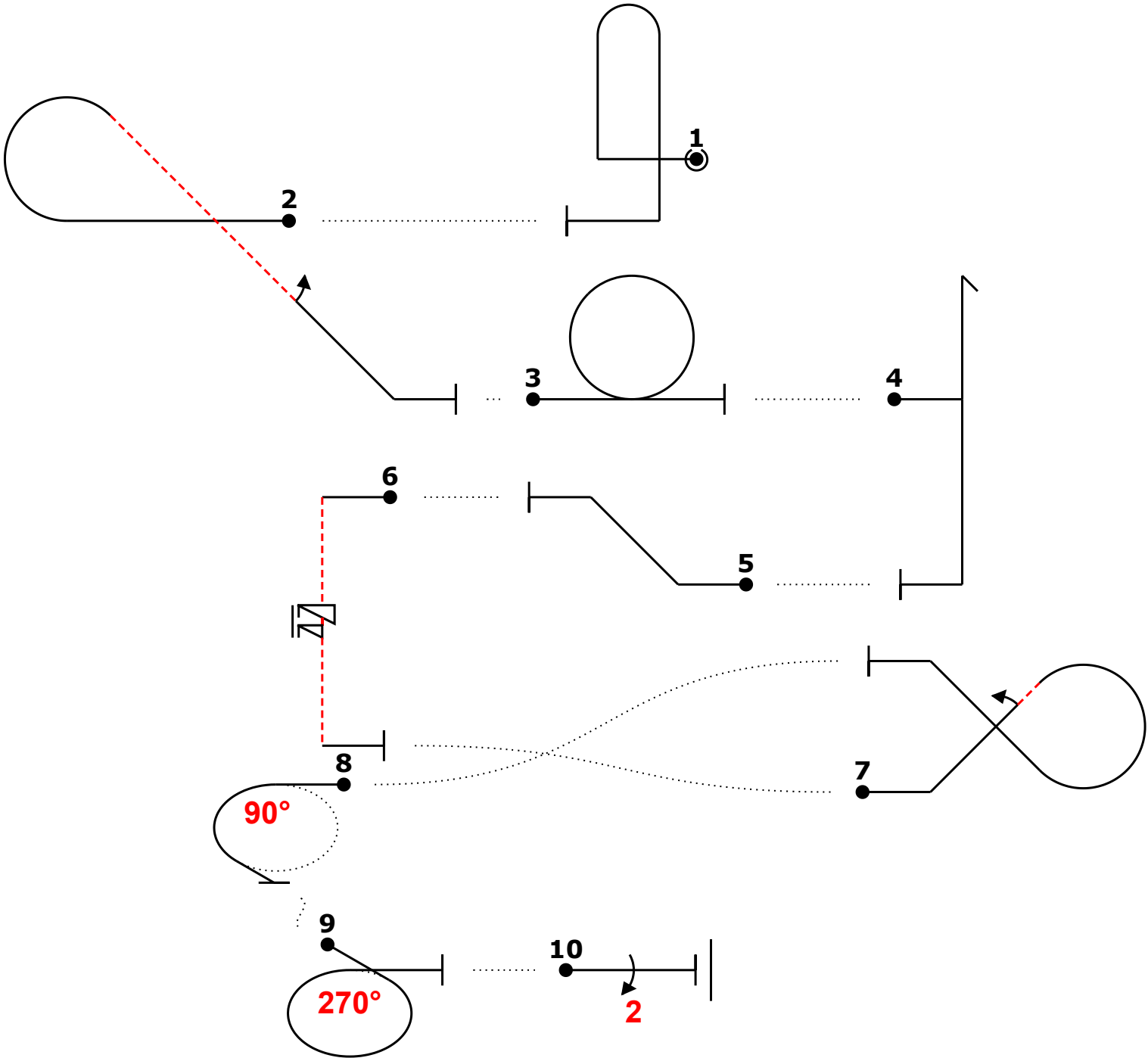
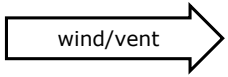

 Pilot
 AAC