

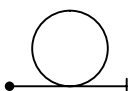

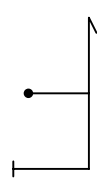

Pilot ID	Entry Known	Flight #
----------	--------------------	----------

No	Symbol	Cat. No.	K	Total K	Example marks:		Remarks	Pos	Item	K	Grade		
					7	5					0	0	
					Zeros and Averages:								
					H	Z	P	Z	A	V			
1		7.4.1.1	10	10 [SF 07]					Framing	2			
											Harmony		
		Fig K	Total K										
		71	73										
2		5.2.1.1	17	17 [SF 05]							Penalties		
3		0.0	8	8 [SF 07]									
4		1.1.1.1 9.1.3.4	2 12	14 [SF 07]									
5		2.1.1.1	3	3 [SF 02]							Judges Details		
6		2.3.1.1	5	5 [SF 02]									
7		1.1.1.1 9.1.3.4	2 12	14 [SF 07]							AUSTRALIAN AEROBATIC CLUB		

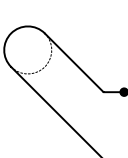
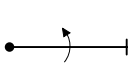



Pilot ID #

Entry Known

Flight #

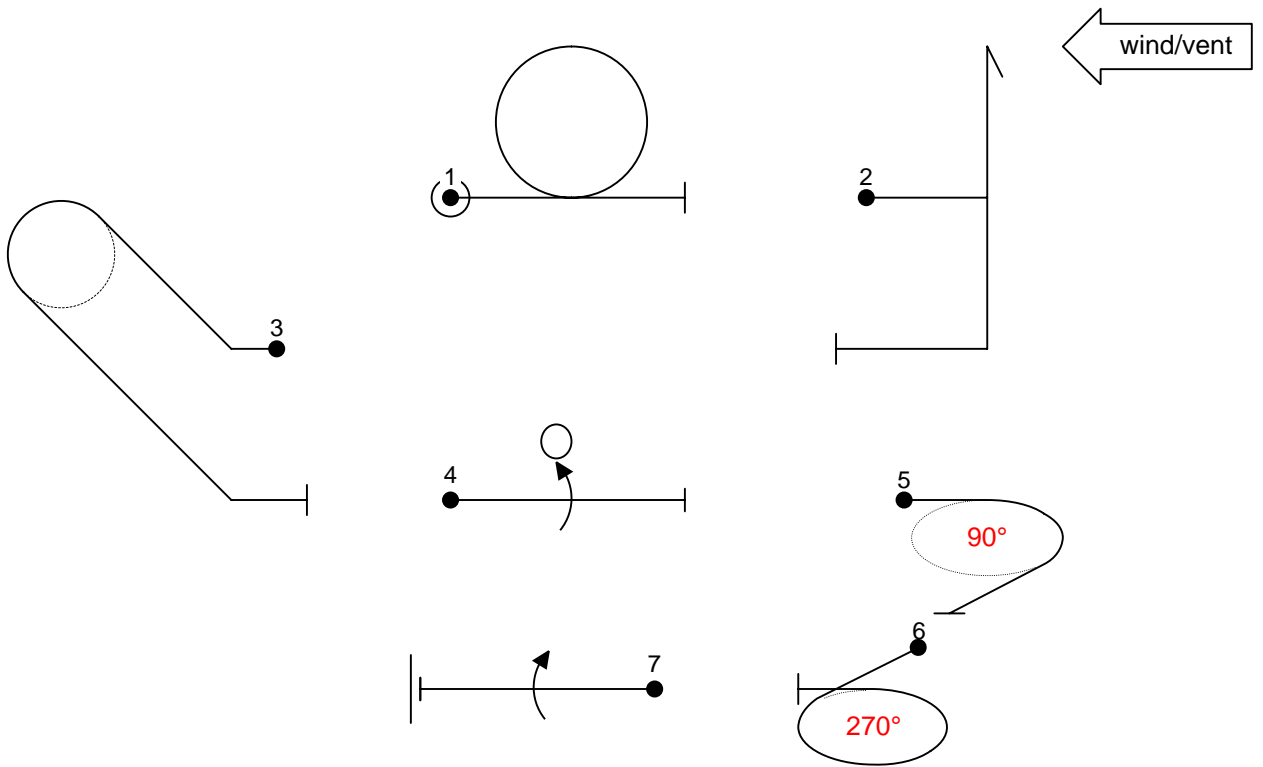
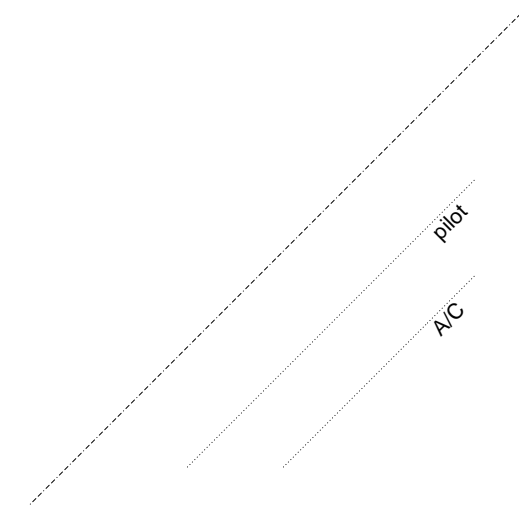

Fig 1	7.4.1.1	10	10
Fig 2	5.2.1.1	17	17
Fig 3	0.0	8	8
Fig 4	1.1.1.1 9.1.3.4	2 12	14
Fig 5	2.1.1.1	3	3
Fig 6	2.3.1.1	5	5
Fig 7	1.1.1.1 9.1.3.4	2 12	14
Total K = 71			





Pilot ID #

Entry Known

Flight #

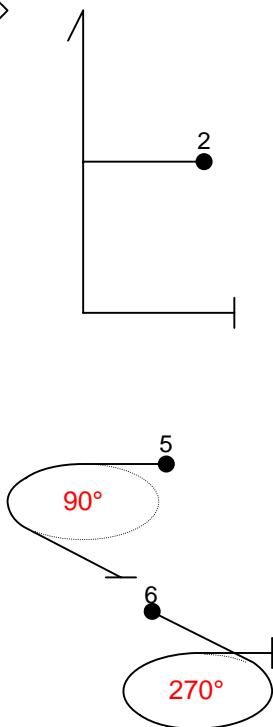
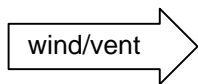

Fig 1	7.4.1.1	10	10
Fig 2	5.2.1.1	17	17
Fig 3	0.0	8	8
Fig 4	1.1.1.1 9.1.3.4	2 12	14
Fig 5	2.1.1.1	3	3
Fig 6	2.3.1.1	5	5
Fig 7	1.1.1.1 9.1.3.4	2 12	14
Total K = 71			

